

R151 PERGOSQUARE

Dettagli tecnici . Technical details

Quote espresse in mm - Dimensions in mm

Piantana . Pole

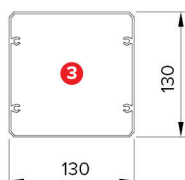

Piede a terra . Foot

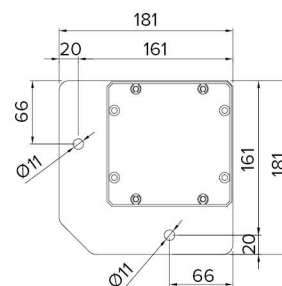
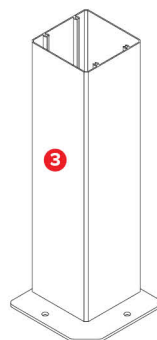

Dettaglio tettuccio . Roof detail

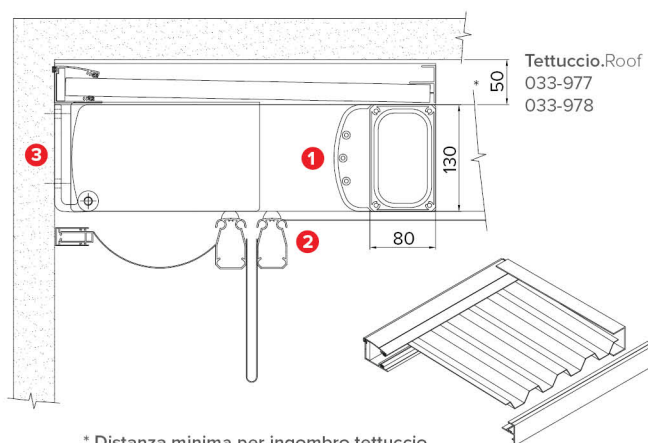

Tettuccio.Roof
033-977
033-978

* Distanza minima per ingombro tettuccio
Minimal distance for roof size

Profili perimetrali in
alluminio estruso e
supporto frontale
13x8cm.
Extruded aluminum
perimetric profiles
and frontal support
of cm. 13x8

Legenda tecnica . Technical legend

- 1 Guida . Rail
- 2 Frangitratta . Flowing profile
- 3 Piantana . Pole

X Impacchettamento . Packing

Dati tecnici . Technical data

Quote espresse in mm - Dimensions in mm

Vista laterale . Side view

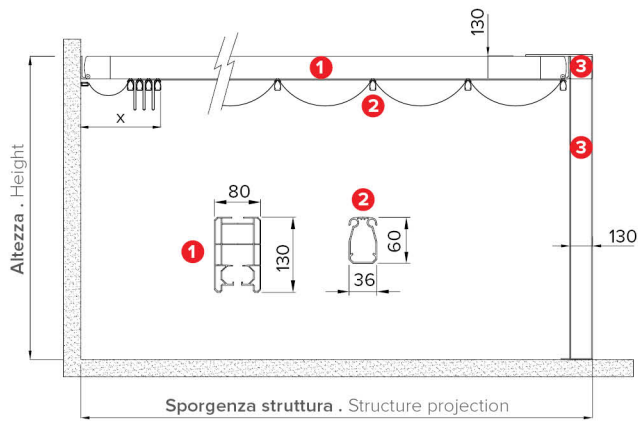

Pendenza telo min. 3% . Cloth inclination min. 3%

Vista frontale . Frontal view

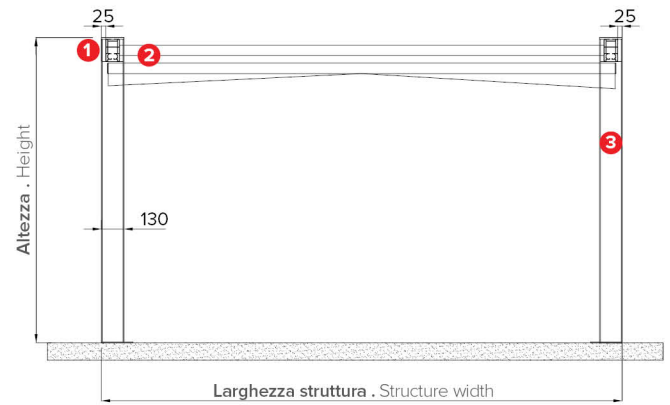

Vista dall'alto . Top view

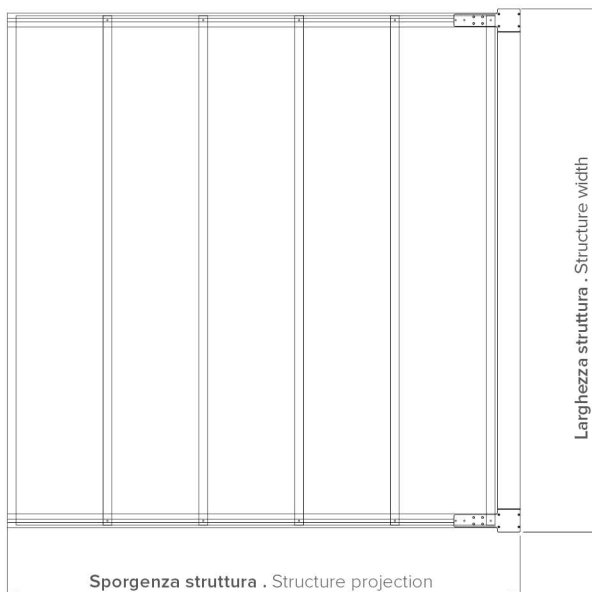

Sporgenza Projection	S cm	200	250	300	350	400	450	500	550	600
Frangitratta indicativi Indicative flowing profiles	n°	4	5	6	7	8	9	10	11	12
Impacchettamento Packing	X cm	47	52	57	62	67	72	77	82	87