

## Dati tecnici . Technical data

Quote espresse in mm - Dimensions in mm

Vista laterale . Side view

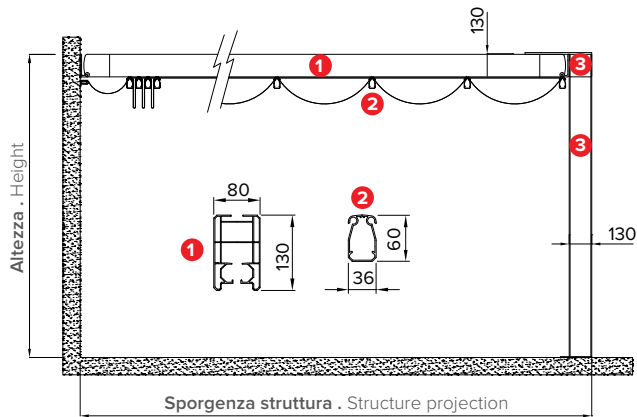

Pendenza telo min. 3% . Cloth inclination min. 3%

Vista frontale . Frontal view

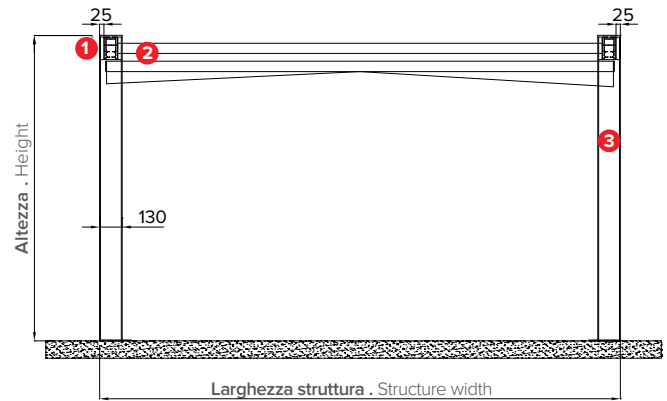

Vista dall'alto . Top view

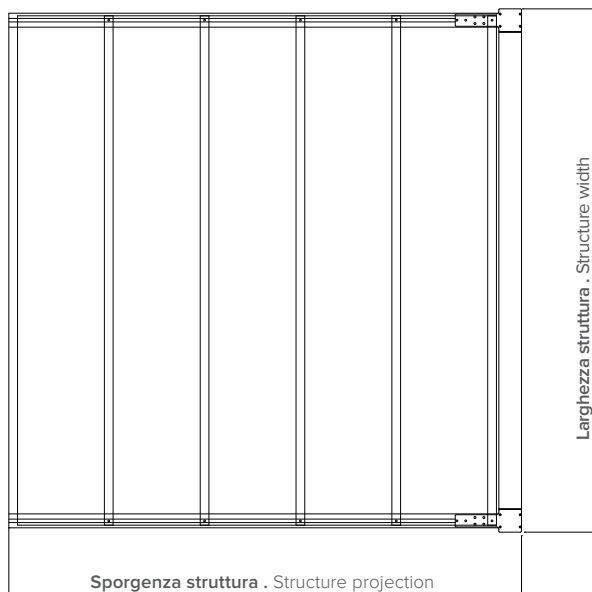

<b>Sporgenza</b> Projection	<b>S cm</b>	200	250	300	350	400	450	500	550	600
<b>Frangitratta indicativi</b> Indicative flowing profiles	<b>n°</b>	4	5	6	7	8	9	10	11	12
<b>Impacchettamento</b> Packing	<b>X cm</b>	47	52	57	62	67	72	77	82	87

# R151 PERGOSQUARE

## Dettagli tecnici . Technical data

Quote espresse in mm - Dimensions in mm

Piantana . Pole

Piede a terra . Foot

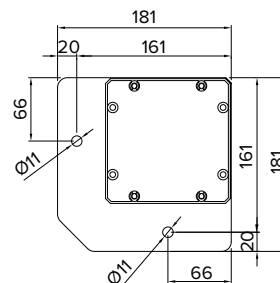
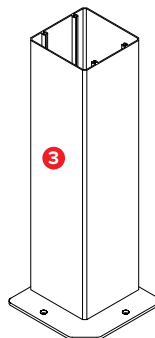
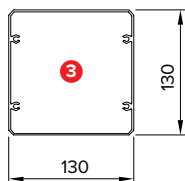

Dettaglio tettuccio . Roof detail

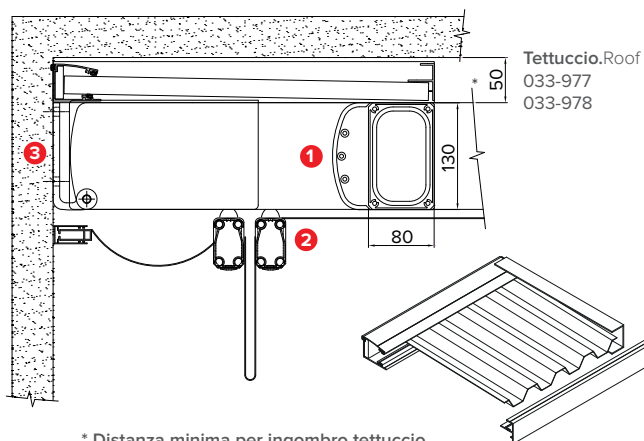

Tettuccio.Roof  
033-977  
033-978

\* Distanza minima per ingombro tettuccio  
Minimal distance for roof size

Profili perimetrali in  
alluminio estruso e  
supporto frontale  
13x8cm.  
Extruded aluminum  
perimetric profiles  
and frontal support  
of cm. 13x8

## Legenda tecnica . Technical legend

- 1 Guida . Rail
- 2 Frangitratta . Flowing profile
- 3 Piantana . Pole

X Impacchettamento . Packing