

R39 MISTRAL FORGED



Peso medio
Medium Weight



9010 BT



7035



Barra quadra . Square bar

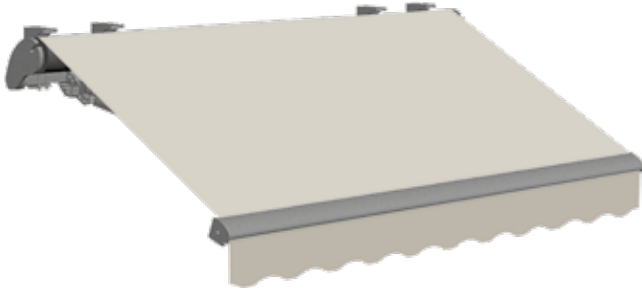

Tenda a barra quadra rinforzata, da mm. 40x40, con bracci a pantografo in alluminio forgiato a caldo. La grande robustezza e le ridotte dimensioni sono le principali caratteristiche. Regolazione micrometrica dell'inclinazione bracci. Funzionamento esclusivamente a motore. Campo di lavoro dei bracci da 5° a 30° dall'orizzontale. Oltre mt. 7.00 di larghezza funzionamento con due motori montati sullo stesso rullo con relativa centralina di comando. Tenda confezionata: L<8mt. pre-assemblata (2/3 colli: rullo, terminale, telo + barra quadra, bracci) senza giunzioni; L>8mt. pre-assemblata (>3 colli: rullo, terminale con giunti + telo + barra quadra con giunti, bracci) con giunzione.

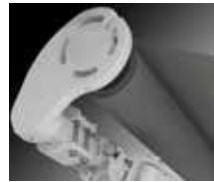
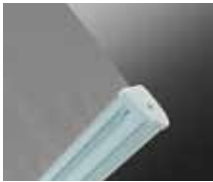

Reinforced arm awning on square bar mm. 40x40, with forged aluminium arms. Great strength and reduced dimensions are its main characteristics. Micrometric regulation of the arms. Working by motor only. Working field of the arms from 5° to 30° at the horizontal. Over mt. 7.00 width it works with two motors put in the same roll with combining relay.

Packaged awning: L<8m. pre-assembled (2/3 packages: roller, terminal, sheet + square bar, arms) without joints; L>8m. pre-assembled (>3 packages: roller, terminal with joints + sheet + square bar with joints, arms) with joint.

Attacco a parete . Wall application

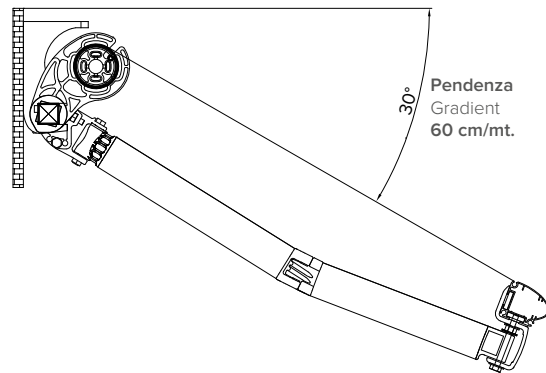
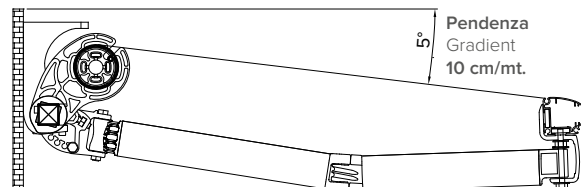
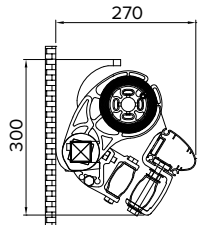
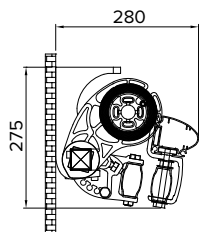

Attacco a soffitto . Ceiling application

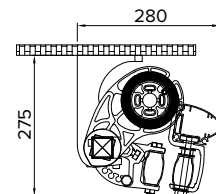

Optional



+ 20%



+ 5%
L< 550 cm.
No Oscurante
No Opatex



+ 12%
L< 550 cm.
No STARLIGHT FR



Mod. 3
art. 027-901
+ 027-902