

# R152 PERGOSQUARE



Peso medio  
Medium Weight

## Dati tecnici . Technical data

Quote espresse in mm - Dimensions in mm

Vista laterale . Side view

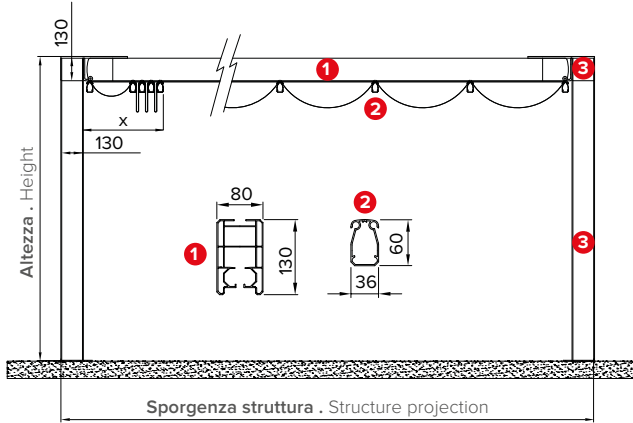

Pendenza telo min. 3% . Cloth inclination min. 3%

Vista frontale . Frontal view

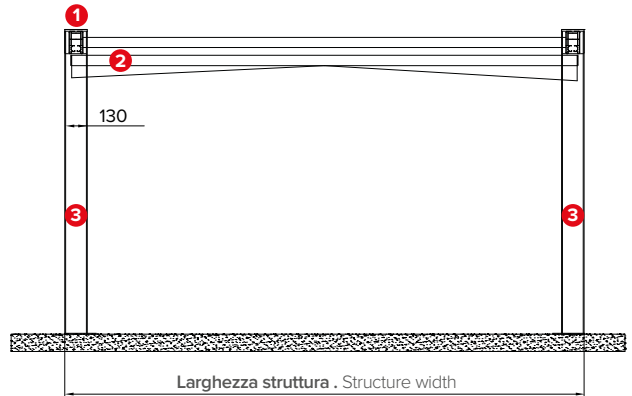

Vista dall'alto . Top view

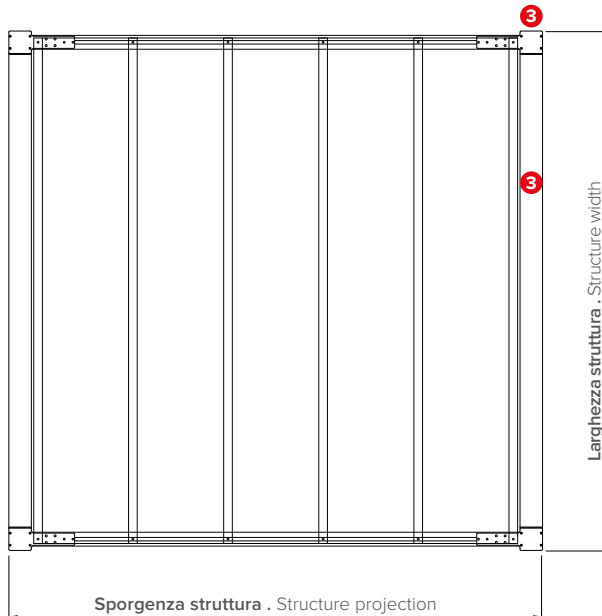

Altezza piantana 13 x 13 cm garantita, H 250 cm, oltre, chiedere fattibilità . Pole height 13 x 13 cm guaranteed, H 250 cm, beyond asking for feasibility.

<b>Sporgenza</b> Projection	<b>S cm</b>	200	250	300	350	400	450	500	550	600
<b>Frangitratta indicativi</b> Indicative flowing profiles	<b>n°</b>	4	5	6	7	8	9	10	11	12
<b>Impacchettamento</b> Packing	<b>X cm</b>	47	52	57	62	67	72	77	82	87



## Dettagli tecnici . Technical details

Quote espresse in mm - Dimensions in mm

Piantana . Pole

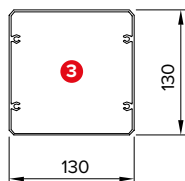

Piede a terra . Foot

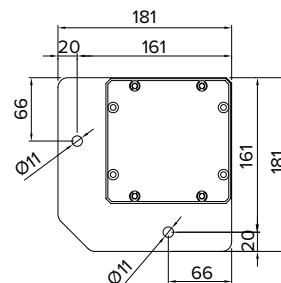
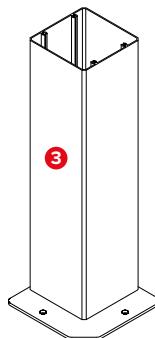

Dettaglio tettuccio . Roof detail  
033-990 / 033-991

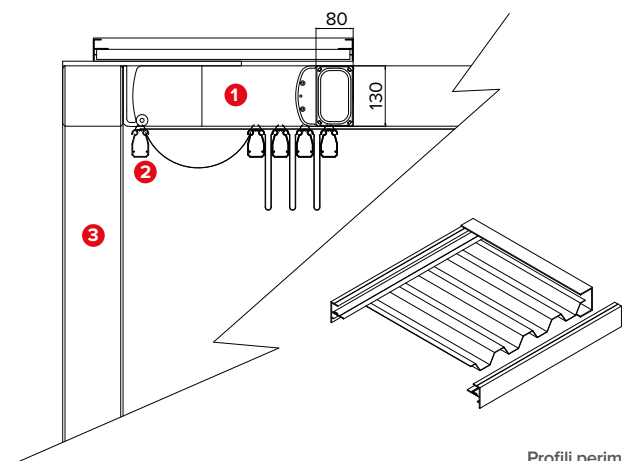

Profili perimetrali in alluminio estruso e supporto frontale 13x8cm.

Extruded aluminum perimetric profiles and frontal support of cm. 13x8

## Legenda tecnica . Technical legend

- 1 Guida . Rail
- 2 Frangitratta . Flowing profile
- 3 Piantana . Pole

X Impacchettamento . Packing